

AXOR®

hansgrohe

DE	Gebrauchsanleitung / Montageanleitung	2
FR	Mode d'emploi / Instructions de montage	3
EN	Instructions for use / assembly instructions	4
IT	Istruzioni per l'uso / Istruzioni per Installazione	5
ES	Modo de empleo / Instrucciones de montaje	6
NL	Gebruiksaanwijzing / Handleiding	7
DK	Brugsanvisning / Monteringsvejledning	8
PT	Instruções para uso / Manual de Instalação	9
PL	Instrukcja obsługi / Instrukcja montażu	10
CS	Návod k použití / Montážní návod	11
SK	Návod na použitie / Montážny návod	12
ZH	用户手册 / 组装说明	13
RU	Руководство пользователя / Инструкция по монтажу	14
HU	Használati útmutató / Szerelési útmutató	15
FI	Käyttöohje / Asennusohje	16
SV	Bruksanvisning / Monteringsanvisning	17
LT	Vartotojo instrukcija / Montavimo instrukcijos	18
HR	Upute za uporabu / Uputstva za instalaciju	19
TR	Kullanım kılavuzu / Montaj kılavuzu	20
RO	Manual de utilizare / Instrucțiuni de montare	21
EL	Οδηγίες χρήσης / Οδηγία συναρμολόγησης	22
SL	Navodilo za uporabo / Navodila za montažo	23
ET	Kasutusjuhend / Paigaldusjuhend	24
LV	Lietošanas pamācība / Montāžas instrukcija	25
SR	Uputstvo za upotrebu / Uputstvo za montažu	26
NO	Bruksanvisning / Montasjeveiledning	27
BG	Инструкция за употреба / Инструкция за употреба	28
SQ	Udhëzuesi i përdorimit / Udhëzime rreth montimit	29
AR	دليل الاستخدام / تعليمات التجميع	30

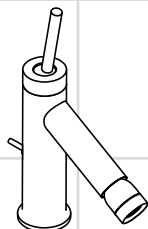

Starck
10211000

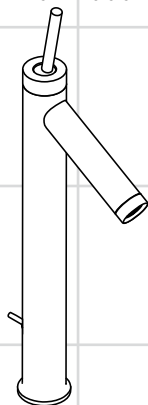

Starck
10120000 / 10129000

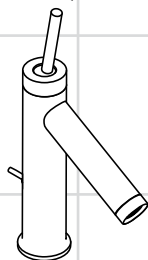

Starck
10006000 / 10111000 /
10116000 / 10117000



Sicherheitshinweise

- ⚠ Bei der Montage müssen zur Vermeidung von Quetsch- und Schnittverletzungen Handschuhe getragen werden.
- ⚠ Das Produkt darf nur zu Bade-, Hygiene- und Körperreinigungszwecken eingesetzt werden.
- ⚠ Große Druckunterschiede zwischen den Kalt- und Warmwasseranschlüssen müssen ausgeglichen werden.

Montagehinweise

- Die Armatur muss nach den gültigen Normen montiert, gespült und geprüft werden.
- Bei Problemen mit dem Durchlauferhitzer oder wenn mehr Wasserdurchsatz gewünscht wird, kann der EcoSmart® (Durchflussbegrenzer), der hinter dem Luftsprudler sitzt entfernt werden.

Technische Daten

Armatur serienmäßig mit EcoSmart® (Durchflussbegrenzer)

Betriebsdruck:	max. 1 MPa
Empfohlener Betriebsdruck:	0,1 - 0,5 MPa
Prüfdruck:	1,6 MPa
(1 MPa = 10 bar = 147 PSI)	
Heißwassertemperatur:	max. 80 °C
Empfohlene Heißwassertemperatur:	65 °C

Hansgrohe Armaturen können in Verbindung mit hydraulisch und thermisch gesteuerten Durchlauferhitzern eingesetzt werden wenn der Fließdruck mindestens 0,15 MPa beträgt.

Symbolerklärung



Kein essigsäurehaltiges Silikon verwenden!



Maße (siehe Seite 34 + 35)



Durchflussdiagramm
(siehe Seite 34 + 35)

- ① mit EcoSmart®
- ② ohne EcoSmart®



Serviceteile (siehe Seite 38)



Sonderzubehör

Montageschlüssel (58085000) nicht im Lieferumfang enthalten



Installationskit nicht im Lieferumfang enthalten



Bedienung (siehe Seite 33)



Reinigung (siehe Seite 37) und beiliegende Broschüre



Prüfzeichen (siehe Seite 36)



Montage siehe Seite 31 + 32



Consignes de sécurité

- ⚠ Lors du montage, porter des gants de protection pour éviter toute blessure par écrasement ou coupure
- ⚠ Le système de douche ne doit servir qu'à se laver et à assurer l'hygiène corporelle.
- ⚠ Il est conseillé d'équilibrer les pressions de l'eau chaude et froide.

Instructions pour le montage

- La robinetterie doit être installée, rincée et contrôlée conformément aux normes valables.
- En cas de problèmes avec le chauffe-eau, ou bien si le débit d'eau doit être plus important, il est possible d'enlever l'EcoSmart® (limiteur de débit) se trouvant derrière l'aérateur.

Informations techniques

Robinetterie équipée en série d'un EcoSmart® (limiteur de débit)

Pression de service autorisée:	max. 1 MPa
Pression de service conseillée:	0,1 – 0,5 MPa
Pression maximum de contrôle: (1 MPa = 10 bar = 147 PSI)	1,6 MPa
Température d'eau chaude:	max. 80 °C
Température recommandée:	65 °C

Les mitigeurs Hansgrohe fonctionnent également en association à des chauffe-eau à commande hydraulique ou thermique à condition que la pression soit au minimum de 0,15 MPa.

Description du symbole



Ne pas utiliser de silicone contenant de l'acide acétique!



Dimensions (voir page 34 + 35)



Diagramme du débit
(voir page 34 + 35)

- ① avec EcoSmart®
- ② sans EcoSmart®



Pièces détachées (voir pages 38)



Special accessories

clé de montage (58085000) ne fait pas partie de la fourniture



Mastic d'installation ne fait pas partie de la fourniture



Instructions de service (voir page 33)



Nettoyage (voir page 37) et brochure ci-jointe





Classification acoustique et débit (voir page 36)



Montage voir page 31 + 32



Safety Notes

-  Gloves should be worn during installation to prevent crushing and cutting injuries.
-  The shower system may only be used for bathing, hygienic and body cleansing purposes.
-  The hot and cold supplies must be of equal pressures.

Installation Instructions

- The fitting must be installed, flushed and tested after the valid norms.
- If the instantaneous water heater causes problems or if you wish to increase the water flow, the EcoSmart® (flow limiter) located behind the aerator can be removed.

Technical Data

This mixer series-produced with EcoSmart® (flow limiter)

Operating pressure:	max. 1 MPa
Recommended operating pressure:	0,1 – 0,5 MPa
Test pressure:	1,6 MPa
(1 MPa = 10 bar = 147 PSI)	
Hot water temperature:	max. 80 °C
Recommended hot water temp.:	65 °C

Hansgrohe mixers can be used together with hydraulically and thermally controlled continuous flow heaters if the flow pressure is at least 0,15 MPa.

Symbol description



Do not use silicone containing acetic acid!



Dimensions (see page 34 + 35)



Flow diagram
(see page 34 + 35)

- ① with EcoSmart®
- ② without EcoSmart®



Spare parts (see page 38)



Special accessories

special tool (58085000) order as an extra



Installation kit order as an extra



Operation (see page 33)



Cleaning (see page 37) enclosed brochure





Test certificate (see page 36)



Assembly see page 31 + 32



Indicazioni sulla sicurezza

-  Durante il montaggio, per evitare ferite da schiacciamento e da taglio bisogna indossare guanti protettivi.
-  Il sistema doccia deve essere utilizzato esclusivamente per l'igiene del corpo.
-  Attenzione! Compensare le differenze di pressione tra i collegamenti dell'acqua fredda e dell'acqua calda.

Istruzioni per il montaggio

- La rubinetteria deve essere installata, pulita e testata secondo le istruzioni riportate!
- Nel caso di problemi con lo scaldacqua oppure nel caso si desiderasse più erogazione, si può eliminare il EcoSmart® (limitatore di flusso) che si trova dietro la valvola di aerazione.

Dati tecnici

Questo miscelatore è dotato di serie del EcoSmart® (limitatore di flusso)

Pressione d'uso:	max. 1 MPa
Pressione d'uso consigliata:	0,1 - 0,5 MPa
Pressione di prova:	1,6 MPa
(1 MPa = 10 bar = 147 PSI)	
Temperatura dell'acqua calda:	max. 80 °C
Temp. dell'acqua calda consigliata:	65 °C

I miscelatori Hansgrohe possono venire usati con caldaie a "bassa pressione" se la pressione di flusso è almeno di 0,15 MPa.

Descrizione simbolo



Non utilizzare silicone contenente acido acetico!



Ingombri (vedi pagg. 34 + 35)



Diagramma flusso
(vedi pagg. 34 + 35)

- ① con EcoSmart®
- ② senza EcoSmart®



Parti di ricambio (vedi pagg. 38)



Accessori speciali

chiave per montaggio (58085000) non contenuto nel volume di fornitura



Mastice d'installazione non contenuto nel volume di fornitura



Procedura (vedi pagg. 33)



Pulitura (vedi pagg. 37) e brochure allegata



Segno di verifica (vedi pagg. 36)



Montaggio vedi pagg. 31 + 32



Indicaciones de seguridad

- ⚠ Durante el montaje deben utilizarse guantes para evitar heridas por aplastamiento o corte.
- ⚠ La grifería solo debe ser utilizada para fines de baño, higiene y limpieza corporal.
- ⚠ Grandes diferencias de presión en servicio entre agua fría y agua caliente deben equilibrarse.

Indicaciones para el montaje

- El grifo tiene que ser instalado, probado y testado, según las normas en vigor.
- En caso de problemas con el calentador instantáneo o cuando se desee más caudal de agua puede quitarse el EcoSmart® (limitador de caudal), situado detrás del aireador.

Datos técnicos

Grifo, desde fábrica equipado con EcoSmart® (limitador de caudal)

Presión en servicio:	max. 1 MPa
Presión recomendada en servicio:	0,1 – 0,5 MPa
Presión de prueba:	1,6 MPa
(1 MPa = 10 bar = 147 PSI)	
Temperatura del agua caliente:	max. 80 °C
Temp. recomendada del agua caliente:	65 °C

Los mezcladores Hansgrohe pueden ser utilizados junto con calentadores continuos de agua que sean manejados de manera hidráulica o térmica, siempre que la presión en servicio ascienda a un mínimo de 0,15 MPa.

Descripción de símbolos



No utilizar silicona que contiene ácido acético!



Dimensiones (ver página 34 + 35)



Diagrama de circulación (ver página 34 + 35)

- ① con EcoSmart®
- ② sin EcoSmart®



Repuestos (ver página 38)



Opcional

Llave de montaje (58085000) no incluido en el suministro



Masilla no incluido en el suministro



Manejo (ver página 33)



Limpiar (ver página 37) y folleto anexo



Marca de verificación (ver página 36)





Veiligheidsinstructies

- ⚠ Bij de montage moeten ter voorkoming van kniel- en snijwonden handschoenen worden gedragen.
- ⚠ Het douchesysteem mag alleen voor het wassen, hygiënische doeleinden en voor de lichaamreiniging worden gebruikt.
- ⚠ Grote drukverschillen tussen de kouden warm wateraansluitingen dienen vermeden te worden.

Montage-instructies

- Leidingen doorspoelen volgens Norm. De mengkraan vervolgens monteren en controleren.
- Wanneer problemen optreden bij doorloopgeisers of wanneer een grotere waterdoorvoer gewenst is, kan de EcoSmart® (doorstroombegrenzer) die achter de perlator is gemonteerd, makkelijk verwijderd worden.

Technische gegevens

Armatuur standaard met EcoSmart®

(doorstroombegrenzer)

Werkdruk: max.

max. 1 MPa

Aanbevolen werkdruk:

0,1 – 0,5 MPa

Getest bij:

1,6 MPa

(1 MPa = 10 bar = 147 PSI)

Temperatuur warm water:

max. 80°C

Aanbevolen warm water temp.:

65°C

Hansgrohe kranen kunnen samen met hydraulisch en thermisch gestuurde geisers gebruikt worden indien de uitstroomdruk min. 0,15 MPa bedraagt.

Symboolbeschrijving



Gebruik geen zuurhoudende silicone!



Maten (zie blz. 34 + 35)



Doorstroomdiagram
(zie blz. 34 + 35)

① met EcoSmart®

② zonder EcoSmart®



Service onderdelen (zie blz. 38)



Toebehoren

montagesleutel (58085000) behoort niet tot het leveringspakket



Kit behoort niet tot het leveringspakket



Bediening (zie blz. 33)



Reinigen (zie blz. 37) en
bijgevoegde brochure



Keurmerk (zie blz. 36)



Montage zie blz. 31 + 32



Sikkerhedsanvisninger

- △ Ved monteringen skal der bruges handsker for at undgå kvæstelser og snitsår.
- △ Brusersystemet må kun bruges til bade-, hygiejne og rengøringsformål.
- △ Større trykforskelte mellem koldt og varmt vand bør udjævnes.

Monteringsanvisninger

- Ifølge gældende regler, skal armaturet monteres, skylles igennem og afprøves.
- Ved problemer med gennemløbsvandvarmer eller hvis der ønskes mere vandgennemstrømning, kan EcoSmart® (gennemstrømningsbegrænseren), der sidder i perlatoren, fjernes.

Tekniske data

Armaturet er forsynet med EcoSmart® (gennemstrømningsbegrænsere)

Driftstryk:	max. 1 MPa
Anbefalet driftstryk:	0,1 – 0,5 MPa
Prøvetryk:	1,6 MPa
(1 MPa = 10 bar = 147 PSI)	
Varmtvandstemperatur:	max. 80 °C
Anbefalet varmtvandstemperatur:	65 °C

Hansgrohe armaturer kan anvendes i forbindelse med hydraulisk- og termiskstyrede gennemstrømningsvandvarmere ved et vandtryk på 0,15 MPa.

Symbolbeskrivelse



Der må ikke benyttes eddikesyreholdig silikone!



Målene (se s. 34 + 35)



Gennemstrømningsdiagram
(se s. 34 + 35)

- ① med EcoSmart®
- ② uden EcoSmart®



Reserve dele (se s. 38)



Specialtilbehør

Monteringsnøgle (58085000) ikke med i leveringsomfang



Kitt ikke med i leveringsomfang



Bediening (se s. 33)



Rengøring (se s. 37) og vedlagt brochure



Godkendelse (se s. 36)





Avisos de segurança

- ⚠ Durante a montagem devem ser utilizadas luvas de protecção, de modo a evitar ferimentos resultantes de entalamentos e de cortes.
- ⚠ O sistema de duche só pode ser utilizado para fins de higiene pessoal.
- ⚠ Grandes diferenças entre as pressões das águas quente e fria devem ser compensadas.

Avisos de montagem

- A misturadora deve ser instalada, purgada e testada de acordo com as normas em vigor.
- Em caso de problemas com o esquentador de água ou se desejar maior débito de água, é possível retirar o EcoSmart® (limitador de caudal), situado por trás do emulsor.

Dados Técnicos

Misturadoras produzidas em série com EcoSmart® (limitador de caudal)

Pressão de funcionamento:	max. 1 MPa
Pressão de func. recomendada:	0,1 – 0,5 MPa
Pressão testada:	1,6 MPa
(1 MPa = 10 bar = 147 PSI)	
Temperatura da água quente:	max. 80 °C
Temp. água quente recomendada:	65 °C

As misturadoras Hansgrohe podem ser utilizadas com esquentadores (de controlo térmico ou hidráulico) desde que a pressão de utilização seja, no mínimo, de 0,15 MPa.

Descrição do símbolo



Não utilizar silicone que contenha ácido acético!



Medidas (ver página 34 + 35)



Fluxograma
(ver página 34 + 35)

- ① com EcoSmart®
- ② sem EcoSmart®



Peças de substituição (ver página 38)



Acessórios especiais

Chave especial (58085000) não incluído no volume de fornecimento



Mástique não incluído no volume de fornecimento



Funcionamento (ver página 33)



Limpeza (ver página 37) e brochura em anexo



Marca de controlo (ver página 36)





Wskazówki bezpieczeństwa

- ⚠ Aby uniknąć zranień, takich jak zgniecenia czy przecięcia, podczas montażu należy nosić rękawice.
- ⚠ Pysznic może być używany tylko do kąpieli, higieny i czyszczenia ciała.
- ⚠ Znaczne różnice ciśnień na doptywach ciepłej i zimnej wody muszą zostać wyrównane.

Wskazówki montażowe

- Armatura musi być zamontowana, przepłukana i wypróbowana według obowiązujących norm.
- W przypadku problemów z przepływowymi podgrzewaczami wody lub jeśli chce się uzyskać większy przepływ wody, można usunąć EcoSmart® (ogranicznik przepływu) znajdujący się za napowietrzaczem.

Dane techniczne

Armatura produkowana seryjnie z funkcją EcoSmart® (ogranicznik przepływu)

Ciśnienie robocze:	maks. 1 MPa
Zalecane ciśnienie robocze:	0,1 – 0,5 MPa
Ciśnienie próbne:	1,6 MPa
(1 MPa = 10 bary = 147 PSI)	
Temperatura wody gorącej:	maks. 80 °C
Zalecana temperatura wody gorącej:	65 °C

Armatura Hansgrohe może być stosowana z przepływowymi podgrzewaczami wody sterowanymi hydraulicznie i termicznie w przypadku, gdy ciśnienie przepływu wynosi co najmniej 0,15 MPa.

Opis symbolu



Nie stosować silikonów zawierających kwas octowy!



Wymiary (patrz strona 34 + 35)



Schemat przepływu (patrz strona 34 + 35)

- ① z EcoSmart®
- ② bez EcoSmart®



Części serwisowe (patrz strona 38)



Wyposażenie specjalne

Klucz montażowy (58085000) Nie jest częścią dostawy



Kit instalatorski Nie jest częścią dostawy



Obsługa (patrz strona 33)



Czyszczenie (patrz strona 37) i dołączona broszura





Znak jakości (patrz strona 36)



Montaż patrz strona 31 + 32



Bezpečnostní pokyny

-  Pro zabránění řezným zraněním a pohmožděninám je nutné při montáži nosit rukavice.
-  Produkt smí být používán pouze ke koupání a za účelem tělesné hygieny.
-  Je nutné vyrovnat velké rozdíly tlaku mezi přípoji studené a teplé vody.

Pokyny k montáži

- Armatura se musí montovat, proplachovat a testovat podle platných norem.
- Při problémech s průtokovým ohřivačem, nebo když je požadován větší průtok, může být odstraněno zařízení EcoSmart® (omezovač průtoku), které je umístěno za perlátorem.

Technické údaje

Armatura je sériově vybavena zařízením

EcoSmart® (omezovač průtoku)

Provozní tlak:	max. 1 MPa
Doporučený provozní tlak:	0,1 – 0,5 MPa
Zkušební tlak:	1,6 MPa
(1 MPa = 10 bar = 147 PSI)	
Teplota horké vody:	max. 80 °C
Doporučená teplota horké vody:	65 °C

Armatury Hansgrohe je možno používat v kombinaci s hydraulicky a tepelně řízenými průtokovými ohřivači v případě, že tlak činí minimálně 0,15 MPa.

Popis symbolů



Nepoužívat silikon s obsahem kyseliny octové!



Rozměry (viz strana 34 + 35)



Diagram průtoku
(viz strana 34 + 35)

- ① se zařízením EcoSmart®
- ② bez zařízení EcoSmart®



Servisní díly (viz strana 38)



Zvláštní příslušenství

montážní klíč (58085000) není součástí dodávky



Instalační kit není součástí dodávky



Ovládání (viz strana 33)



Čištění (viz strana 37) a přiložená brožura



zkušební značka (viz strana 36)





Bezpečnostné pokyny

- ⚠ Pri montáži musíte nosiť rukavice, aby ste predišli pomliaždeninám a rezným poraneniam.
- ⚠ Produkt sa smie používať len na kúpanie a telesnú hygienu.
- ⚠ Veľké rozdiely v tlaku medzi prípojkami studenej a teplej vody musia byť vyrovnané.

Pokyny pre montáž

- Armatúra sa musí montovať, preplachovať a testovať podľa platných noriem.
- Pri problémoch s prietokovým ohrievačom alebo ak je požadovaný väčší prietok vody, môže sa demontovať zariadenie EcoSmart® (obmedzovač prietoku), ktoré je umiestnené za perlátorom.

Technické údaje

Armatúra je sériovo vybavená zariadením EcoSmart® (obmedzovač prietoku)

Prevádzkový tlak:	max. 1 MPa
Doporučený prevádzkový tlak:	0,1 – 0,5 MPa
Skúšobný tlak:	1,6 MPa
(1 MPa = 10 bar = 147 PSI)	
Teplota teplej vody:	max. 80 °C
Doporučená teplota teplej vody:	65 °C

Batérie Hansgrohe môžete používať v spojení s hydraulickými a tepelne ovládanými prietokovými ohrievačmi, ak je tlak minimálne 0,15 MPa.

Popis symbolov



Nepoužívať silikón s obsahom kyseliny octovej!



Rozmery (viď strana 34 + 35)



Diagram prietoku
(viď strana 34 + 35)

- ① so zariadením EcoSmart®
- ② bez zariadenia EcoSmart®



Servisné diely (viď strana 38)



Zvláštne príslušenstvo

montážny kľúč (58085000) nie je súčasťou dodávky



Inštalácia súprava nie je súčasťou dodávky



Obsluha (viď strana 33)



Čistenie (viď strana 37) a priložená brožúra



Osvedčenie o skúške (viď strana 36)





⚠️ 安全技巧

- △ 装配时为避免挤压和切割受伤，必须戴上手套。
- △ 淋浴系统只允许作为洗浴、卫生和洁身之用。
- △ 冷热水管间过大的压力差必须予以平衡。

安装提示

- 必须按照现行的规定安装，冲洗和测试产品。
- 如果使用即热式热水器时出现问题，或要求更大的水流量，可以把位于水波器后面的 EcoSmart (流量限制器) 拆除。

技术参数

本龙头配有 EcoSmart (流量限制器)

工作压强:	最大 1 MPa
推荐工作压强:	0,1 0,5 MPa
测试压强:	1,6 MPa
(1 MPa = 10 bar = 147 PSI)	
热水温度:	最大 80° C
推荐热水温度:	65° C

如果水压达到0,15 MPa以上，汉斯格雅双手柄龙头可以和液压式或热控式连续流热水器一起使用。

符号说明



请勿使用含有乙酸的硅！



大小 (参见第34 + 35页)



流量示意图
(参见第34 + 35页)

- ① 带有 EcoSmart
- ② 无 EcoSmart



备用零件 (参见第38页)



选装附件

专用工具 (58085000) 不在供货范围内



水管胶泥 不在供货范围内



操作 (参见第 33 页)



清洗 (参见第 37 页) 并附有小手册





检验标记 (参见第36页)



安装 参见第31 + 32页



Указания по технике безопасности

-  Во время монтажа следует надеть перчатки во избежание прищемления и порезов.
-  Изделие разрешается использовать только в гигиенических целях: для принятия ванны и личной гигиены.
-  донного клапа. Перед установкой смесителя необходимо регулировочными кранами выровнять давление холодной и горячей воды при помощи вентилей регулирующих подачу воды в квартиру.

Указания по монтажу

- Смеситель должен быть смонтирован по действующим нормам и в соответствии с настоящей инструкцией, проверен на герметичность и безупречность работы.
- Если возникнут проблемы с проточным бойлером или потребуется увеличить расход воды, то можно удалить EcoSmart® (ограничитель потока воды), который установлен за воздушным рассекателем.

Технические данные

Смесители этой серии серийно оснащаются EcoSmart® (ограничителем потока воды)

Рабочее давление:	не более. 1 МПа
Рекомендуемое рабочее давление:	0,1 – 0,5 МПа
Давление:	1,6 МПа
(1 МПа = 10 bar = 147 PSI)	
Температура горячей воды:	не более. 80 °С
Рекомендуемая темп. гор. воды:	65 °С

Арматуры Hansgrohe могут использоваться в комбинации с проточными нагревателями с гидравлическим и термическим управлением, если давление истечения составляет не менее 0,15 МПа.

Описание символов



Не применяйте силикон, содержащий искусственную кислоту.



Размеры (см. стр. 34 + 35)



Схема потока
(см. стр. 34 + 35)

- ① С EcoSmart®
- ② Без EcoSmart®



Комплект (см. стр. 38)



Специальные принадлежности

Монтажный ключ (58085000) не включено в объем поставки!



Монтаж подводки не включено в объем поставки!



Эксплуатация (см. стр. 33)



Очистка (см. стр. 37) и прилагаемая брошюра



Знак технического контроля
(см. стр. 36)





Biztonsági utasítások

- ⚠ A szerelésnél a zúzódások és vágási sérülések elkerülése érdekében kesztyűt kell viselni.
- ⚠ A terméket csak fürdéshez, mosakodáshoz, és egészségügyi tisztálkodáshoz szabad használni.
- ⚠ A hidegvíz- és a melegvíz-csatlakozások közötti nagy nyomáskülönbséget kikell egyenlíteni!

Szerelési utasítások

- A csaptelepet az érvényben lévő előírásoknak megfelelően kell felszerelni, átöblíteni és ellenőrizni.
- Ha problémák adódnak az átfolyós vízmelegítővel vagy nagyobb átfolyó vízmennyiségre van szükség, akkor az EcoSmart® (átfolyáskorlátozó) eltávolítható a perlátor mögül.

Műszaki adatok

A csaptelep szériakivitelben el van látva EcoSmart® (átfolyáskorlátozó) berendezéssel

Üzemi nyomás:	max. 1 MPa
Ajánlott üzemi nyomás:	0,1 – 0,5 MPa
Nyomáspróba:	1,6 MPa
(1 MPa = 10 bar = 147 PSI)	
Forróvíz hőmérséklet:	max. 80 °C
Forróvíz javasolt hőmérséklete:	65 °C

A Hansgrohe csaptelepek hidraulikus és termikus vezérlésű átfolyós melegítővel kapcsolatban is használhatóak, ha az átfolyó nyomás legalább 0,15 MPa.

Szimbólumok leírása



Ne használjon ecetsavtartalmú szilikon!



Méretet (lásd a 34 + 35. oldalon)



Átfolyási diagramm (lásd a 34 + 35. oldalon)

- ① EcoSmart® berendezéssel
- ② EcoSmart® nélkül



Tartozékok (lásd a 38. oldalon)



Egyéb tartozék

Szerelőkulcs (58085000) a szállítási egység nem tartalmazza



szaniter szilikon a szállítási egység nem tartalmazza



Használat (lásd a 33. oldalon)



Tisztítás (lásd a 37. oldalon) és mellékelt brossúrával



Vizsgajel (lásd a 36. oldalon)



Szerelés lásd a 31 + 32. oldalon



Turvallisuusohjeet

- △ Asennuksessa on käytettävä käsineitä puristumien ja viiltojen aiheuttamien tapaturmien estämiseksi.
- △ Suihkujärjestelmää saa käyttää ainoastaan kylpy-, hygienia- ja puhdistustarkoituksiin.
- △ Suuret paine-erot kylmä- ja kuumavesiliitännöiden välillä on tasattava.

Asennusohjeet

- Kaluste on asennettava, huuhdeltava ja tarkastettava voimassa olevien määräysten mukaisesti.
- Jos läpivirtauskuumentimen kanssa on ongelmia tai jos halutaan suurempaa veden virtausmäärää, voidaan poreenmuodostajan takana oleva EcoSmart® (virtausrajoitin) poistaa.

Tekniset tiedot

Kaluste on vakiona varustettu EcoSmart®

(virtausrajoittimella)

Käyttöpaine:	maks. 1 MPa
Suosittelut käyttöpaine:	0,1 – 0,5 MPa
Koestuspaine:	1,6 MPa
(1 MPa = 10 bar = 147 PSI)	
Kuuman veden lämpötila:	maks. 80 °C
Kuuman veden suosituslämpötila:	65 °C

Hansgrohe kalusteita voi käyttää hydraulisesti tai termisesti ohjattujen läpivirtauskuumentimien yhteydessä, jos virtauspaine on vähintään 0,15 MPa.

Merkin kuvaus



Älä käytä etikkahappopitoista silikonia!



Mitat (katso sivu 34 + 35)



Virtausdiagrammi
(katso sivu 34 + 35)

- ① sisältää EcoSmart®
- ② ilman EcoSmart®



Varaosat (katso sivu 38)



Eriyisvaruste

Asennusavain (58085000) ei kuulu toimitukseen



Asennussarja ei kuulu toimitukseen



Käyttö (katso sivu 33)



Puhdistus (katso sivu 37) ja oheinen esite





Koestusmerkki (katso sivu 36)





Säkerhetsanvisningar

-  Handskar ska bäras under monteringsarbetet så att man kan undvika kläm- och skärskadorgen werden.
-  Produkten får bara användas till kroppshygien med bad och dusch.
-  Stora tryckskillnader mellan anslutningarna för varmt och kallt vatten måste utjämnas.

Monteringsanvisningar

- Armaturen måste installeras, genomspolas och testas enligt gällande föreskrifter.
- Om det är problem med vattenberedaren eller om större vattenflöde önskas kan EcoSmart® (flödeskontroll) som sitter bakom perlatorn tas bort.

Tekniska data

Blandare seriemässigt med EcoSmart® (flödeskontroll)

Driftstryck:	max. 1 MPa
Rek. driftstryck:	0,1 - 0,5 MPa
Tryck vid provtryckning:	1,6 MPa
(1 MPa = 10 bar = 147 PSI)	
Varmvattentemperatur:	max. 80 °C
Rek. varmvattentemp.:	65 °C

Hansgrohe blandare kan användas tillsammans med hydrauliskt och termiskt styrda varmvattenberedare när flödestrycket uppgår till minst 0,15 MPa.

Simbolio aprašymas



Använd inte silikon som innehåller ättiksyra!



Måtten (se sidan 34 + 35)



Pralaidumo diagrama
(se sidan 34 + 35)

- ① med EcoSmart®
- ② utan EcoSmart®



Reservdelar (se sidan 38)



Specialtillbehör

Monteringsnyckel (58085000) medföljer ej leveransen



Installationskit medföljer ej leveransen



Hantering (se sidan 33)



Rengöring (se sidan 37) och medföljande broschyr



Testsigill (se sidan 36)





Saugumo technikos nurodymai

- ⚠️ Apsaugai nuo užspaudimo ir įsijovimo montavimo metu mūvėkite pirštines.
- ⚠️ Gaminy s turi būti naudojami tik maudymuisi, kūno higienai ir švarai palaikyti.
- ⚠️ Turi būti išlyginti šalto ir karšto slėgio nelygumai.

Montavimo instrukcija

- Maišytuvą privalo būti montuojamas ir išbandomas pagal veikiančias normas ir šią instrukciją.
- Jei yra problemų su momentiniu vandens šildytuvu ar neužtenka vandens srauto, galima pašalinti už aeratoriaus esantį „EcoSmart®“ (vandens srauto ribotuvą).

Techniniai duomenys

Šios serijos maišytuvai turi EcoSmart® (vandens srauto ribotuvą)

Darbinis slėgis: ne daugiau kaip 1 MPa

Rekomenduojamas slėgis: 0,1 – 0,5 MPa

Bandomasis slėgis: 1,6 MPa

(1 MPa = 10 barų = 147 PSI)

Karšto vandens temperatūra: ne daugiau kaip 80°C

Rekomenduojama karšto vandens temperatūra: 65°C

„Hansgrohe“ maišytuvai gali būti naudojami su hidrauliškai ir termiškai reguliuojamais momentiniais šildikliais, kai vandens slėgis mažesnis kaip 0,15 MPa.

Simbolio aprašymas



Nenaudokite silikono, kurio sudėtyje yra acto rūgšties!



Išmatavimai (žr. psl. 34 + 35)



Pralaidumo diagrama

(žr. psl. 34 + 35)

① su EcoSmart®

② be EcoSmart®



Atsarginės dalys (žr. psl. 38)



Specialūs priedai

Montavimo raktas (58085000) nėra pridedama



Montavimo rinkinys nėra pridedama

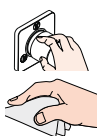

Eksplotacija (žr. psl. 33)

Valymas (žr. psl. 37) ir pridedama brošiūra





Bandyimo pažyma (žr. psl. 36)





Sigurnosne upute

-  Prilikom montaže se radi sprječavanja prignječenja i posjekotina moraju nositi rukavice.
-  Proizvod se smije primjenjivati samo za kupanje, tuširanje i osobnu higijenu.
-  Velika razlika u pritisku između vruće i hladne vode mora biti izbalansirana.

Upute za montažu

- Cijevi moraju biti postavljene, isprane i testirane prema važećim normama.
- Ako dolazi do problema s protočnim bojlerom ili se želi veći protok vode, može se ukloniti EcoSmart® (limitator protoka) lociran iza aeratora.

Tehnički podaci

Armatura ima serijski ugrađen EcoSmart®

(limitator protoka)

Najveći dopušteni tlak:	tlak 1 MPa
Preporučeni tlak:	0,1 – 0,5 MPa
Probni tlak:	1,6 MPa
(1 MPa = 10 bar = 147 PSI)	
Temperatura vruće vode:	tlak 80 °C
Preporučena temperatura vruće vode:	65 °C

Hansgrohe armature mogu se koristiti u kombinaciji sa hidraulički i termički kontroliranim protočnim bojlerima ukoliko tlak iznosi najmanje 0,15 MPa

Opis simbola



Nemojte koristiti silikon koji sadrži octenu kiselinu!



Mjere (pogledaj stranicu 34 + 35)



Dijagram protoka
(pogledaj stranicu 34 + 35)

- ① s limitatorom EcoSmart®
- ② bez limitatora EcoSmart®



Rezervni dijelovi (pogledaj stranicu 38)



Posebni pribor

ključ za montažu (58085000) Nije sadržano u isporuci!



Instalaterski kit Nije sadržano u isporuci!



Upotreba (pogledaj stranicu 33)



Čišćenje (pogledaj stranicu 37) i priložena brošura



Oznaka testiranja (pogledaj stranicu 36)





Güvenlik uyarıları

- ⚠ Montaj esnasında ezilme ve kesilme gibi yaralanmaları önlemek için eldiven kullanılmalıdır.
- ⚠ Duş sistemi yalnızca banyo, hijyen ve beden temizliği amaçları doğrultusunda kullanılabilir.
- ⚠ Sıcak ve soğuk su bağlantıları arasında büyük basınç farklılıkları varsa, bu basınç farklılıklarının dengelenmesi gerekir.

Montaj açıklamaları

- Batarya monte edilmeli, geçerli normlardan sonra akış testi yapılmalıdır.
- Sürekli akışlı su ısıtıcıları ile birlikte kullanımında problemler söz konusu ise veya akan su miktarının daha fazla olması isteniyorsa, perlatörün arka tarafındaki EcoSmart® (akış sınırlayıcısı) sökülüp çıkarılabilir.

Teknik bilgiler

Batarya EcoSmart® (akış sınırlayıcısı) ile birlikte seri olarak

İşletme basıncı:	azami 1 MPa
Tavsiye edilen işletme basıncı:	0,1 – 0,5 MPa
Kontrol basıncı:	1,6 MPa
(1 MPa = 10 bar = 147 PSI)	
Sıcak su sıcaklığı:	azami 80°C
Tavsiye edilen su ısısı:	65°C

Hansgrohe bataryaları, akış basıncı en az 0,15 MPa olursa hidrolik ve termik kumandalı şofbenlerle bağlantılı olarak kullanılabilir.

Simge açıklaması



Asetik asit içeren silikon kullanmayın!



Ölçüleri (Bakınız sayfa 34 + 35)



Akış diyagramı
(Bakınız sayfa 34 + 35)

- ① EcoSmart® dahil
- ② EcoSmart® hariç



Yedek Parçalar (Bakınız sayfa 38)



Özel aksesuarlar

Montaj anahtarı (58085000) Teslimat kapsamına dahil değildir



Montaj silikonu Teslimat kapsamına dahil değildir



Kullanımı (Bakınız sayfa 33)



Temizleme (Bakınız sayfa 37) ve birlikte verilen broşür





Kontrol işareti (Bakınız sayfa 36)





Instrucțiuni de siguranță

-  La montare utilizați mănuși pentru evitarea contuziunilor și tăierii mâinilor.
-  Sistemul de duș poate fi utilizat doar pentru spălarea, menținerea igienei și curățarea corpului.
-  Diferențele de presiune mari între alimentarea cu apă rece și apă caldă trebuie echilibrate.

Instrucțiuni de montare

- Bateria trebuie montată, clătită și verificată conform normelor în vigoare.
- Dacă apar probleme cu boilerul instant sau dacă doriți un debit de apă mai mare, puteți să demontați unitatea EcoSmart® (limitatorul de debit), care se află în spatele suflătorului de aer.

Date tehnice

Bateria este dotată în serie cu EcoSmart®

(limitator de debit)

Presiune de funcționare:	max. 1 MPa
Presiune de funcționare recomandată:	0,1 – 0,5 MPa
Presiune de verificare:	1,6 MPa
(1 MPa = 10 bar = 147 PSI)	
Temperatura apei calde:	max. 80 °C
Temperatura recomandată a apei calde:	65 °C

Bateriile Hansgrohe pot fi utilizate cu boiler instant cu comandă termică sau hidraulică dacă presiunea apei de alimentare este de min. 0,15 MPa.

Descrierea simbolurilor



Nu utilizați silicon cu conținut de acid acetic!



Dimensiuni (vezi pag. 34 + 35)



Diagrama de debit
(vezi pag. 34 + 35)

- ① cu EcoSmart®
- ② fără EcoSmart®



Piese de schimb (vezi pag. 38)



Accesorii opționale

Cheie pentru montare (58085000) nu este inclus în setul livrat



Chit de instalare nu este inclus în setul livrat



Utilizare (vezi pag. 33)



Curățare (vezi pag. 37) și broșura alăturată



Certificat de testare (vezi pag. 36)





Υποδειξεις ασφαλείας

- ⚠ Για να αποφύγετε τραυματισμούς κατά τη συναρμολόγηση πρέπει να φοράτε γάντια.
- ⚠ Το προϊόν επιτρέπεται να χρησιμοποιείται μόνο σαν μέσο λουτρού, υγιεινής και καθαρισμού του σώματος.
- ⚠ Οι διαφορές της πίεσης μεταξύ της σύνδεσης κρύου και ζεστού νερού θα πρέπει να αντισταθμίζονται.

Οδηγίες συναρμολόγησης

- Η μπαταρία πρέπει να τοποθετηθεί, να πλυθεί και να ελεγχθεί με βάση τους ισχύοντες κανόνες υδραυλικής τέχνης
- Εάν παρουσιαστεί πρόβλημα με τον ταχυθερμοσίφωνα ή όταν απαιτείται περισσότερο νερό, μπορεί να απομακρυνθεί ο EcoSmart® (μειωτής ροής), ο οποίος βρίσκεται πίσω από το φίλτρο του ρουξουνιού.

Τεχνικά Χαρακτηριστικά

Μπαταρία μόνιμα εξοπλισμένη με EcoSmart®

(μειωτής ροής)

Λειτουργία πίεσης:

Συνιστώμενη λειτουργία πίεσης:

Πίεση ελέγχου:

(1 MPa = 10 bar = 147 PSI)

Θερμοκρασία ζεστού νερού:

Συνιστώμενη θερμοκρασία ζεστού νερού:

έως 1 MPa

0,1 - 0,5 MPa

1,6 MPa

έως 80 °C

65 °C

Οι βάνες Hansgrohe μπορούν να συνδυαστούν με ταχυθερμοσίφωνες υδραυλικού και θερμικού ελέγχου, όταν η πίεση ροής αριθμεί τουλάχιστον 0,15 MPa.

Περιγραφή συμβόλων



Μην χρησιμοποιείτε σιλικόνη που περιέχει οξικό οξύ!



Διαστάσεις (βλ. σελίδα 34 + 35)



Διάγραμμα ροής
(βλ. σελίδα 34 + 35)

① με EcoSmart®

② χωρίς EcoSmart®



Ανταλλακτικά (βλ. σελίδα 38)



Ειδικά αξεσουάρ

Κλειδί συναρμολόγησης (58085000) δεν περιλαμβάνεται στον παραδοτέο εξοπλισμό



Κιτ εγκατάστασης δεν περιλαμβάνεται στον παραδοτέο εξοπλισμό



Χειρισμός (βλ. σελίδα 33)



Καθαρισμός (βλ. σελίδα 37) και συνημμένο φυλλάδιο





Σήμα ελέγχου (βλ. σελίδα 36)





Varnostna opozorila

-  Pri montaži je treba nositi rokavice, da se preprečijo poškodbe zaradi zmečkanja ali urezov.
-  Ta izdelek se sme uporabljati le z namenom umivanja, vzdrževanja higiene in telesne nege.
-  Velike razlike v tlaku med priključkom za mrzlo in priključkom za toplo vodo je potrebno izravnati.

Instructions pour le montage

- Armatura je potrebno montirati, splakniti in testirati v skladu z veljavnimi predpisi.
- Če imate probleme s pretočnim grelnikom, ali če želite večji pretok vode, lahko odstranite EcoSmart® (omejevalnik pretoka), ki se nahaja za perlatorjem.

Tehnični podatki

Armatura je serijsko opremljena z EcoSmart®

(omejevalnik pretoka)

Delovni tlak:	maks. 1 MPa
Priporočeni delovni tlak:	0,1 - 0,5 MPa
Preskusni tlak:	1,6 MPa
(1 MPa = 10 bar = 147 PSI)	
Temperatura tople vode:	maks. 80 °C
Priporočena temperatura tople vode:	65 °C

Armature Hansgrohe lahko uporabljate v povezavi s hidravlično in termično uravnavanimi pretočnimi grelniki, če je pretočni tlak najmanj 0,15 MPa.

Opis simbola



Ne smete uporabiti silikona, ki vsebuje očetno kislino!



Mere (glejte stran 34 + 35)



Diagram pretoka
(glejte stran 34 + 35)

- ① z omejevalnikom pretoka EcoSmart®
- ② brez omejevalnika pretoka EcoSmart®



Rezervni deli (glejte stran 38)



Poseben pribor

Montažni ključ (58085000) Ni vključeno



Komplet za montažo Ni vključeno



Upravljanje (glejte stran 33)



Čiščenje (glejte stran 37) in priložena brošura





Preskusni znak (glejte stran 36)



Montaža Glejte stran 31 + 32.



Ohutusjuhised

-  Kandke paigaldamisel muljumis- ja löikevigastuste vältimiseks kindaid.
-  Toodet tohib kasutada ainult pesemis-, hügieeni- ja kehahapustamiseesmärkidel.
-  Kui külma ja kuuma vee ühenduste surve on väga erinev, tuleb need tasakaalustada.

Paigaldamisjuhised

- Seadmestiku paigaldamine, läbipesu ja kontrollimine peab toimuma vastavalt kehtivatele normidele.
- Kui esineb probleeme läbivooluboileiga või kui soovitate, et vee läbivool oleks suurem, tuleks sõela taga asuv EcoSmart® (veehulgapiiraja) eemaldada.

Tehnilised andmed

Segistisari on toodetud koos EcoSmart®

(veehulgapiirajaga)

Töörõhk

maks. 1 MPa

Soovitav töörõhk:

0,1 – 0,5 MPa

Kontrollsurve:

1,6 MPa

(1 MPa = 10 baari = 147 PSI)

Kuuma vee temperatuur:

maks. 80 °C

Soovitav kuuma vee temperatuur:

65 °C

Hansgrohe segisteid võib kasutada koos hüdrauliliselt ja termiliselt juhitavate boileritega, kui vee surve on vähemalt 0,15 MPa.

Sümbolite kirjeldus



Ärge kasutage äädikhapet sisaldavat silikooni!



Mõõtude (vt lk 34 + 35)



Läbivooludiagramm
(vt lk 34 + 35)

① EcoSmart® olemas

② EcoSmart® puudub



Varuosad (vt lk 38)



Spetsiaalne lisavarustus

Montaaživõti (58085000) ei sisaldu komplektis



Paigalduskomplekt ei sisaldu komplektis



Kasutamine (vt lk 33)



Puhastamine (vt lk 37) ja kaasasolev brošüür





Kontrollsertifikaat (vt lk 36)





Drošības norādes

-  Montāžas laikā, lai izvairītos no saspiedumiem un iegriezumiem, nepieciešams nēsāt cimdus.
-  Šo produktu drīkst izmantot tikai, lai mazgātos, higiēnai un ķermeņa tīrīšanai.
-  Jāizlīdzina spiediena atšķirības starp aukstā un karstā ūdens pievadiem.

Norādījumi montāžai

- Jaucējkrāns jāmontē, jāskalo un jāpārbauda atbilstoši spēkā esošajām normām.
- Ja rodas problēmas ar caurteces sildītāju vai ja ūdens plūsma nav pietiekami spēcīga, EcoSmart® (caurteces ierobežotāju), kas atrodas aiz aeratora, drīkst noņemt.

Tehniskie dati

Jaucējkrāns tiek ražots kopā ar EcoSmart®

(caurteces ierobežotāju)

Darba spiediens:	maks. 1 MPa
leteicamais darba spiediens:	0,1 – 0,5 MPa
Pārbaudes spiediens:	1,6 MPa
(1 MPa = 10 bar = 147 PSI)	
Karstā ūdens temperatūra:	maks. 80 °C
leteicamā karstā ūdens temperatūra:	65 °C

Hansgrohe jaucejkrānus var izmantot kombinācijā ar hidrauliski un termiski vadāmiem caurteces sildītājiem, ja plūsmas spiediens ir vismaz 0,15 MPa.

Simbolu nozīme



Neizmantojiet silikonu, kas satur etiķskābi!



Izmērus (skat. 34 + 35. lpp.)



Caurplūdes diagramma
(skat. 34 + 35. lpp.)

- ① ar EcoSmart®
- ② bez EcoSmart®



Rezerves daļas (skat. 38. lpp.)



Speciāli aksesuāri

Montāžas atslēga (58085000) komplektā netiek piegādāts



Instalācijas piederumi komplektā netiek piegādāts



Lietošana (skat. 33. lpp.)



Tīrīšana (skat. 37. lpp.) un klāt pievienotais buklets



Pārbaudes zīme (skat. 36. lpp.)





Sigurnosne napomene

- ⚠ Prilikom montaže se radi sprečavanja prignječenja i posekotina moraju nositi rukavice.
- ⚠ Proizvod sme da se koristi samo za kupanje, tuširanje i ličnu higijenu.
- ⚠ Velika razlika u pritisku između vruće i hladne vode mora biti izbalansirana.

Instrukcije za montažu

- Armatura mora biti postavljena, isprana i testirana prema važećim normama.
- Ukoliko se pojave problemi sa protočnim bojlerom ili se želi veći protok vode, onda EcoSmart® (ograničavač protoka vode), koji je smešten iza aeratora, može da se ukloni.

Tehnički podaci

Ove armature imaju serijski ugrađen

EcoSmart® (ograničavač protoka vode)

Radni pritisak:	maks. 1 MPa
Preporučeni radni pritisak:	0,1 – 0,5 MPa
Probni pritisak:	1,6 MPa
(1 MPa = 10 bar = 147 PSI)	
Temperatura vruće vode:	maks. 80 °C
Preporučena temperatura vruće vode:	65 °C

Hansgrohe armature se mogu koristiti u kombinaciji s hidraulički i termički kontrolisanim protočnim bojlerima ukoliko pritisak iznosi najmanje 0,15 MPa.

Opis simbola



Nemojte koristiti silikon koji sadrži sirćetnu kiselinu!



Mere (vidi stranu 34 + 35)



Dijagram protoka
(vidi stranu 34 + 35)

- ① sa ograničavačem EcoSmart®
- ② bez ograničavača EcoSmart®



Rezervni delovi (vidi stranu 38)



Poseban pribor

ključ za montažu (58085000) Nije sadržano u isporuci



Instalaterski komplet Nije sadržano u isporuci



Rukovanje (vidi stranu 33)



Čišćenje (vidi stranu 37) i priložena brošura





Ispitni znak (vidi stranu 36)





Sikkerhetshenvisninger

-  Bruk hansker under montasjen for å unngå klem- og kuttskader.
-  Dusjsystemet skal kun brukes for bade-, hygiene- og kroppshygiene.
-  Store trykkdifferanser mellom kaldt- og varmtvannstilkoblinger skal utlignes.

Montagehenvisninger

- Armaturen skal monteres, spyles og sjekkes iht. gjeldende standarder.
- Ved problemer med gjennomstrømningsovnen, eller når man ønsker en større vanngjennomstrømning, kan EcoSmart® (gjennomstrømningsbegrenser) fjernes. Den sitter bak luftdysene.

Tekniske data

Armatur er standardmessig utstyrt med

EcoSmart® (gjennomstrømningsbegrenser)

Driftstrykk	maks. 1 MPa
Anbefalt driftstrykk:	0,1 – 0,5 MPa
Prøvetrykk	1,6 MPa
(1 MPa = 10 bar = 147 PSI)	
Varmtvannstemperatur	maks. 80 °C
Anbefalt temperatur for varmt vann	65 °C

Armaturer fra Hansgrohe kan brukes sammen med hydraulisk og termisk strypte gjennomstrømningsovner når gjennomstrømningsstrykket er på minst 0,15 MPa.

Symbolbeskrivelse



Ikke bruk silikon som inneholder eddiksyre!



Mål (se side 34 + 35)



Gjennomstrømningsdiagram
(se side 34 + 35)

- ① med EcoSmart®
- ② uten EcoSmart®



Serviceleder (se side 38)



Ekstratilbehør

Montasjenøkkel (58085000) ikke med i leveransen



Installasjonskitt ikke med i leveransen



Betjening (se side 33)



Rengjøring (se side 37) og vedlagt brosjyre





Prøvermerke (se side 36)



Montasje se side 31 + 32



Указания за безопасност

-  При монтажа трябва да се носят ръкавици, за да се избегнат наранявания поради притискане или порязване.
-  Позволено е използването на продукта само за къпане, хигиена и цели на почистване на тялото.
-  Големите разлики в налягането между изводите за студената и топлата вода трябва да се изравняват.

Указания за монтаж

- Арматурата трябва да се монтира, промие и провери в съответствие с валидните норми.
- При проблеми с проточния нагревател или когато желаете по-голяма пропускателна способност на водата, може да отстраните EcoSmart® (ограничителя на протичане), който се намира зад аератора.

Технически данни

Арматурата е оборудвана серийно с EcoSmart® (ограничител на протичане)

Работно налягане:	макс. 1 МПа
Препоръчително работно налягане:	0,1 – 0,5 МПа
Контролно налягане:	1,6 МПа
(1 МПа = 10 bar = 147 PSI)	
Температура на горещата вода:	макс. 80 °C
Препоръчителна температура на горещата вода:	65 °C

Арматурите на Hansgrohe могат да се използват във връзка с хидравлично и термично управляеми проточни нагреватели, ако хидравличното налягане е минимум 0,15 МПа.

Описание на символите



Не използвайте силикон, съдържащ оцетна киселина!



Размери (вижте стр. 34 + 35)



Диаграма на потока (вижте стр. 34 + 35)

- ① с EcoSmart®
- ② без EcoSmart®



Сервизни части (вижте стр. 38)



Специални принадлежности

Монтажен ключ (58085000) не се съдържа в обема на доставка



Инсталационен кит не се съдържа в обема на доставка



Обслужване (вижте стр. 33)



Почистване (вижте стр. 37) и приложена брошура



Контролен знак (вижте стр. 36)



Монтаж вижте стр. 31 + 32



Udhëzime sigurie

- △ Për të evituar lëndimet e pickimeve ose të prerjeve gjatë procesit të montimit duhet që të vishni doreza.
- △ Produkti duhet të përdoret vetëm qëllimet e banjave, të higjienës dhe të larjes së trupit.
- △ Ndryshimet e mëdha të presionit mes lidhjeve të ujit të ftohtë dhe atij të ngrohtë duhen ekuilibruar.

Udhëzime për montimin

- Armatura duhet montuar, shpërlarë dhe kontrolluar në bazë të normave të vlefshme.
- Nëse lindin probleme me ngrohësin e ujit ose nëse dëshironi të keni më shumë qarkullim uji, atëherë EcoSmart® (kufizuesi i qarkullimit të ujit), i cili ndodhet pas ajrosësit, mund të çmontohet.

Të dhëna teknike

Rubineti është i pajisur si standard me

EcoSmart® (Kufizues qarkullimi)

Presioni gjatë punës	maks. 1 MPa
Presioni i rekomanduar:	0,1 – 0,5 MPa
Presioni për provë:	1,6 MPa
(1 MPa = 10 bar = 147 PSI)	
Temperatura e ujit të ngrohtë	maks. 80 °C
Temperatura e rekomanduar e ujit të ngrohtë:	65 °C

Armaturat e Hansgrohe mund të përdoren në kombinim me ngrohës elektrikë të ujit të drejtuar në mënyrë hidraulike ose termike nëse presioni i rrjedhjes është minimumi 0,15 MPa.

Përshkrimi i simbolit



Mos përdorni silikon që në përbërje ka acid acetik.



Përmasat (shih faqen 34 + 35)



Diagrami i qarkullimit
(shih faqen 34 + 35)

- ① me EcoSmart®
- ② pa EcoSmart®



Pjesë ndërrimi (shih faqen 38)



Pajisje të posaçme

Çelësi i montimit (58085000) nuk përfshihet në vëllimin e furnizimit



Stuko për instalim nuk përfshihet në vëllimin e furnizimit



Përdorimi (shih faqen 33)



Pastrimi (shih faqen 37) dhe broshura bashkëngjitur



Shenja e kontrollit (shih faqen 36)



Montimi shih faqen 31 + 32



وصف الرمز

هام! لا تستخدم السليكون الذي يحتوي على أحماض!

أبعاد (راجع صفحة 35 + 34)

رسم للصراف
(راجع صفحة 36)

① ب EcoSmart®

② بدون EcoSmart®

قطع الغيار (راجع صفحة 38)

ملحقات خاصة

مفتاح التركيب (58085000) غير مدرج مع المحتويات المسلمة

طقم تركيب غير مدرج مع المحتويات المسلمة

التشغيل (راجع صفحة 33)

التنظيف (راجع صفحة 37) والكتيب المرفق

شهادة اختبار (راجع صفحة 36)



تنبيهات الأمان



- ⚠ يجب ارتداء قفازات لليد أثناء التركيب لتجنب حدوث أضرار الإنحسار أو الجروح.
- ⚠ لا يجب استخدام نظام الدش إلا في أغراض الاستحمام والأغراض الصحية وأغراض تنظيف الجسم.
- ⚠ يجب أن يكون تيار الماء الساخن والماء البارد متعادلين في الضغط.

تعليمات التركيب

- يجب تركيب الوصلة واستخدامها واختبارها وفقاً للمعايير المعمول بها.
- إذا تسبب سخان الماء الجاري في أية مشكلات أو في حالة الرغبة في وجود تدفق أكثر للماء، يجب فك EcoSmart® (محدد تدفق المياه) الموجود خلف تجهيزة التهوية.

المواصفات الفنية

يتم بشكل قياسي إنتاج الخلاط هذا مع EcoSmart® (محدد تدفق المياه)

الحد الأقصى 1 ميجاباسكال

ضغط التشغيل: 0,1 – 0,5 ميجاباسكال

ضغط الاختبار: 1,6 ميجاباسكال

(1 ميجاباسكال = 10 بار = 147 PSI)

الحد الأقصى 80°C

درجة حرارة الماء الساخن: 65°C

يمكن استخدام خلاطات هانزجروهي مع سخانات تدفق الماء ذات التحكم الهيدروليكي و الحراري، مع ضغط تدفق لا يقل عن 0,15 ميجاباسكال.



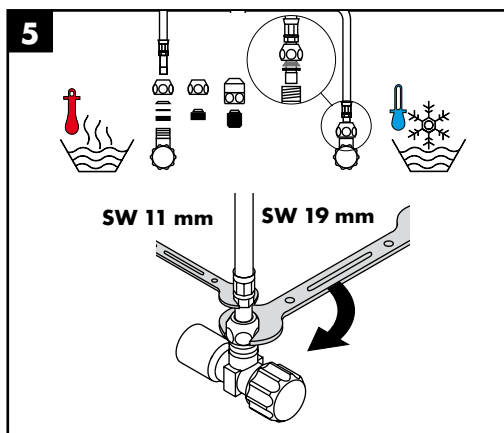
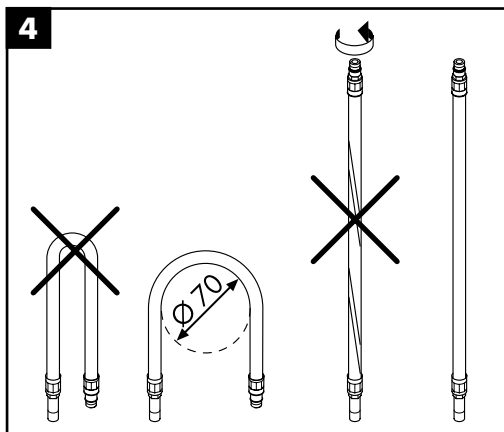
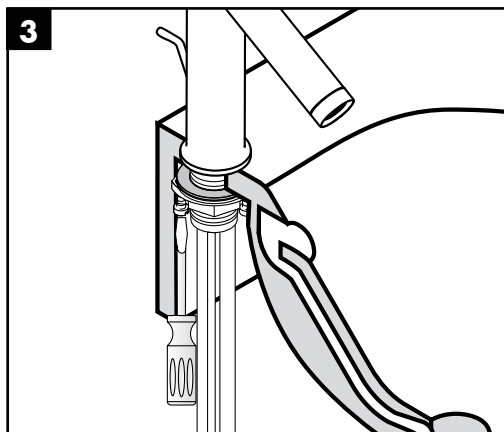
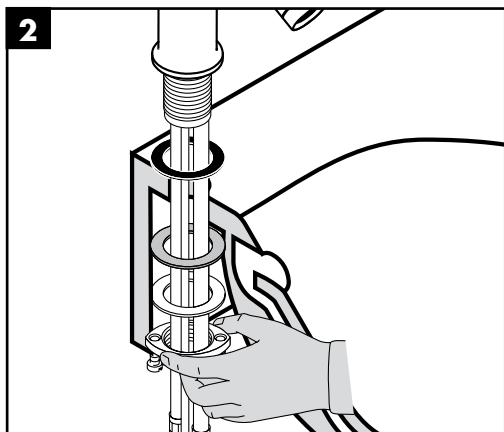
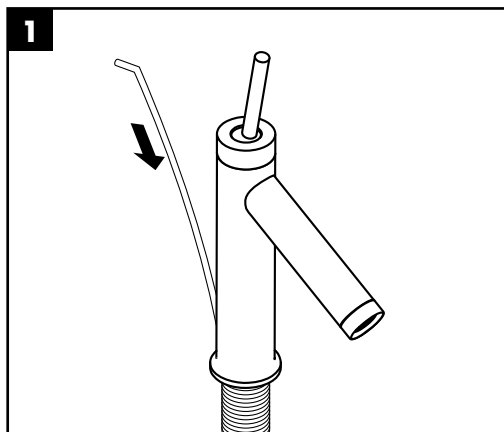

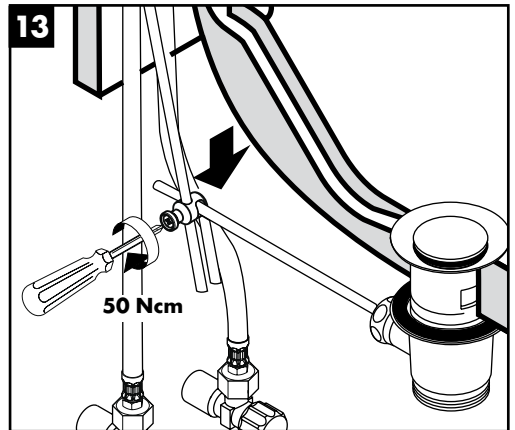
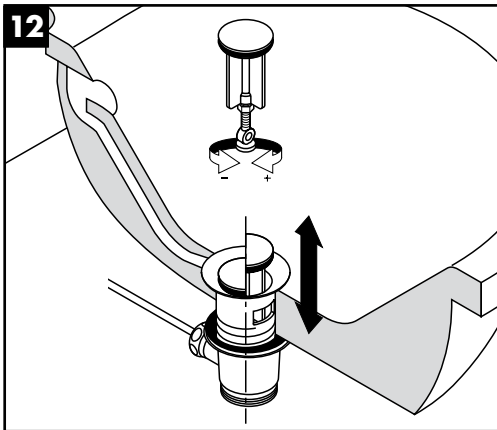
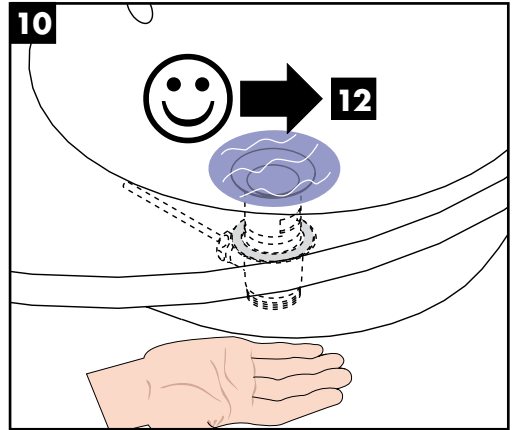
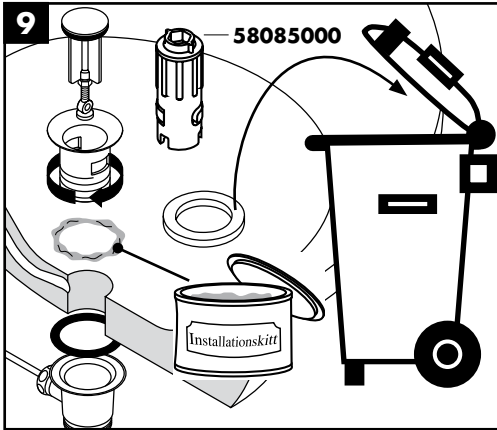
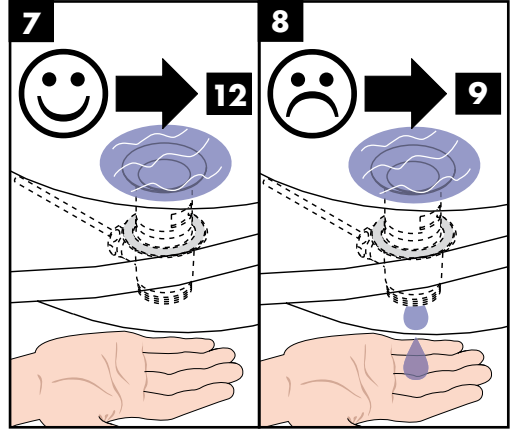
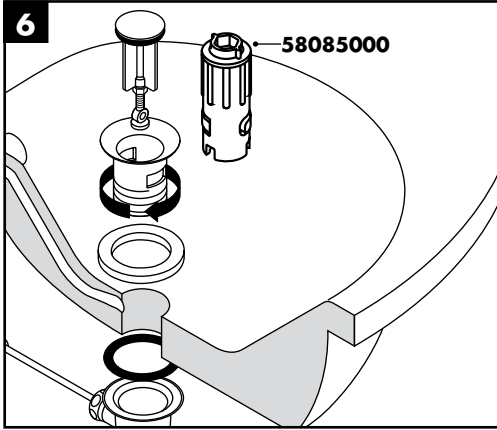

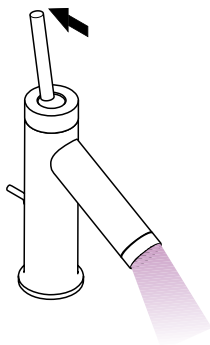

öffnen / ouvert / open / aperto / abierto / open / åbne /
abrir / otworzyć / otevřít / otvorit / 开 / открыть / nyitás /
avaaminen / öppna / atidaryti / Отваранье / açmak /
deschide / ανοικτό / odpreti / avage / atvērt /
otvoriti / åpne / отварање / hape / فتح

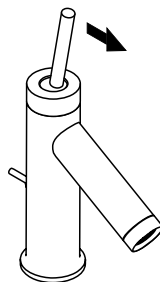

schließen / fermé / close / chiudere / cerrar / sluiten /
lukke / fechar / zamknąć / zavřít / uzavriet / 关 /
закреть / bezárás / sulkeminen / stänga / uždaryti /
Zatvaranje / karatmak / închide / κλειστό /
zapreti / sulgege / aizvērt / zatvori / lukke / затваряне /
mbylle / إغلاق

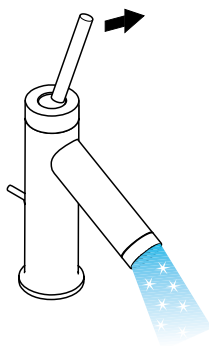

kalt / froid / cold / freddo / frío / koud / koldt / fria /
zimna / studená / studená / 冷 / холодная / hideg /
kylmä / kallt / šaltas / Hladno / soğuk / rece / κρύο /
mrzlo / külm / auksts / hladno / kaldt / студено / i ftohtë /
بارد

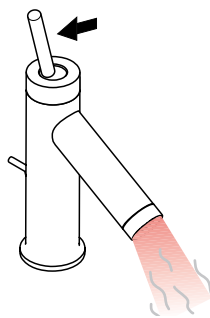

warm / chaud / hot / caldo / caliente / warm / varmt /
quente / ciepła / teplá / teplá / 热 / горячая / meleg /
lämmin / varmt / karštas / Vruća voda / sıcak / cald /
Ζεστό / toplo / kuum / karsts / topla / varm / тепло /
i ngrohtë / ساخن



Starck
10006000

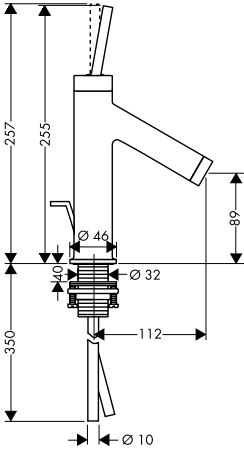

Starck
10111000 / 10117000

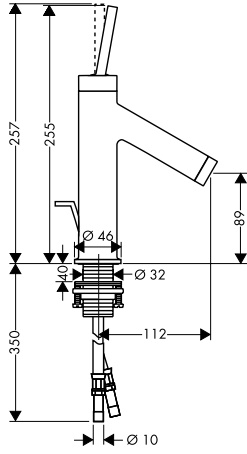

Starck
10116000

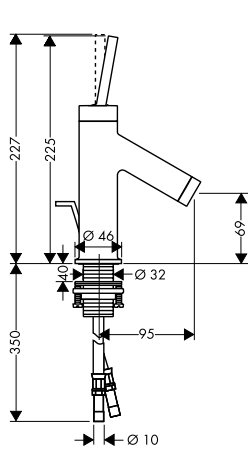

Starck
10120000 / 10129000

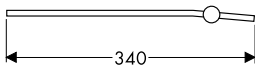
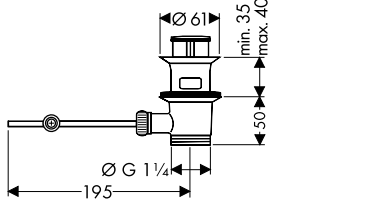
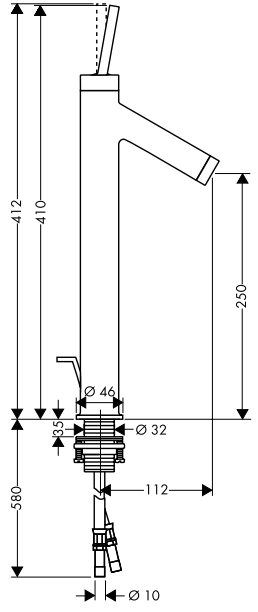

Starck
10006000 / 10111000 / 10116000 / 10117000 / 10120000 / 10129000

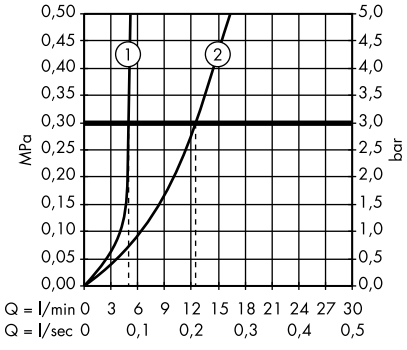

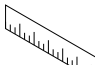

Starck
10211000

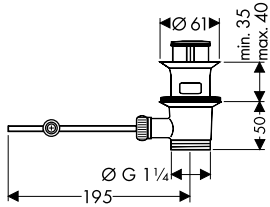
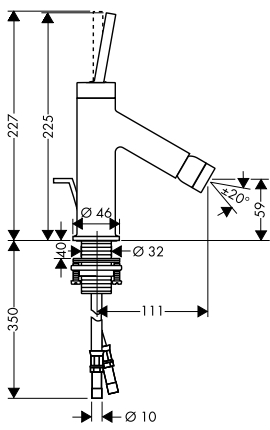

Starck
10211000

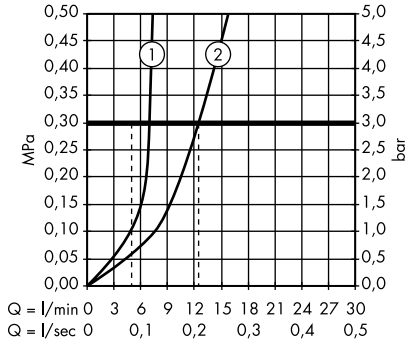



	P-IX	DVGW	SVGW	WRAS	KIWA	NF	ACS	ETA
10006000		X					X	X
10111000	P-IX 9698/IA	X	X	X	X		X	
10116000	P-IX 9698/IA	X	X	X	X		X	
10117000	P-IX 9698/IA	X					X	
10120000	P-IX 9698/IA	X	X	X			X	
10129000	P-IX 9698/IA	X					X	
10211000	P-IX 9698/IA	X	X		X		X	





QUICK CLEAN

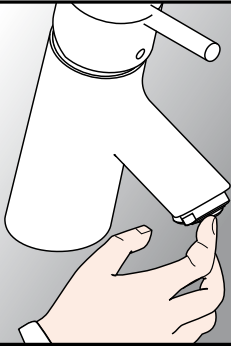

DE Mit QuickClean, der manuellen Reinigungsfunktion können die Strahlformer durch einfaches rubbelen vom Kalk befreit werden.

FR La pomme de douche est équipée de QuickClean, le système anticalcaire manuel. Les dépôts de calcaire s'enlèvent en frottant avec un doigt ou avec une éponge sur les ouvertures de jets élastiques.

EN The QuickClean cleaning function only needs a small manual rub over to remove the lime scale from the spray channels.

IT Con QuickClean, la funzione anticalcare manuale, i diffusori del getto possono essere liberati da calcare con un semplice strofinamento.

ES QuickClean, la función de limpieza manual, permite quitar la cal simplemente frotando los ejectores.

NL Met QuickClean, de handmatige reinigingsfunctie, kunnen de straalopeningen door het met de hand wegwrijven van kalk, gereinigd worden.

DK Med QuickClean, den manuelle rengøringsfunktion kan strålekanalerne let renses for kalk - der skal blot gnubbes!

PT O sistema de limpeza QuickClean requer apenas uma ligeira passagem com a mão para remover os depósitos de calcário do emulсор.

PL Funkcja QuickClean wymaga jedynie delikatnego potarcia dłonią, aby usunąć ewentualne osady kamienia wapiennego.

CS S ruční čistící funkcí QuickClean stačí jednoduché odstranění vodního kamene prsty z trysek kotouče tvarujícího proud vody.

SK Čistiaca funkcia QuickClean, stačí na jednoduché odstránenie vodného kameňa prstami z trysiek kotúča tvarujúceho prúd vody.

ZH 有了QuickClean, 手工清洁功能, 要去掉喷头上的水垢, 只需简单地搓除即可。

RU система QuickClean позволяет удалять известковые отложения, достаточно провести по эластичной поверхности аэратора пальцем, как известковые отложения будут удалены.

HU A QuickClean manuális tisztítófunkciónak köszönhetően a vízsugáryílások egyszerű ledörzsöléssel megtisztíthatóak a vízkőtől.

FI QuickClean -käsitöminen kalkinpoistojärjestelmä on helppo käyttää: hiero sormella ja vedentulo on taas esteetön.

SV Med QuickClean, den manuella rengöringsfunktionen, är det lätt att befria strålekanalerna från kalk - de ska bar gnuggas.

LT "QuickClean" valymo funkcija apsaugo nuo apkalkėjimo. Užtenka pirštu nubraukti atsiradusius nešvarumus nuo srovės angų.

HR QuickClean - ručni sustav za čišćenje omogućuje jednostavnim trljanjem odstranjivanje kamenca sa rupica prskalice tuša.

TR QuickClean, üründe bulunan bir temizleme fonksiyonudur. Basit bir ovuşturma ile spray modüllerdeki kireci çözer.

RO Cu ajutorul sistemului QuickClean puteți să îndepărtați depunerile de calcar de pe diferitele duze de jet de apă prin frecare.

EL Με QuickClean, η λειτουργία καθαρισμού με το χέρι, μπορούν να απομακρυνθούν με απλό τρίψιμο τα άλατα από τα κανάλια του καταιονιστήρα.

SI Z QuickClean, ročno čistilno funkcija, lahko s šob očistimo vodni kamen tako, da šobe enostavno podrgnemo.

ET Käsitö puhastamise funktsiooni QuickClean puhul on vajalik vaid kerge ülehõõrumine, eemaldamaks dušikanalitest katlakivi.

LV QuickClean attīrīšanas funkcija - strūklas kanāliņi vienkāršas manuālas berzes rezultātā tiek attīrīti no kaļķa.

SR QuickClean - ručni sistem za čišćenje omogućuje odstranjivanje kamenca s rupica uobičajavača mlaza, jednostavnim trljanjem.

NO Med Quiclean, den manuelle rengjøringsfunksjonen, kan stråleformere renses for kalk ved hjelp av enkel gnikking.

BG С QuickClean, ръчната функция за почистване, приспособленията за оформяне на струята могат да се почистват от варовика с просто разтъркване.

SQ Me QuickCleanit®, funksionin manual të pastrimit mund të hiqen mbetjet gëlqerore me fërkim të thjeshtë nga formuesit e currilit.

AR وباستخدام برنامج التنظيف "QuickClean" الذي يتميز بخاصية التنظيف الآلي، يمكن تنظيف وحدات دفع المياه من الجير عن طريق حكها برفق.

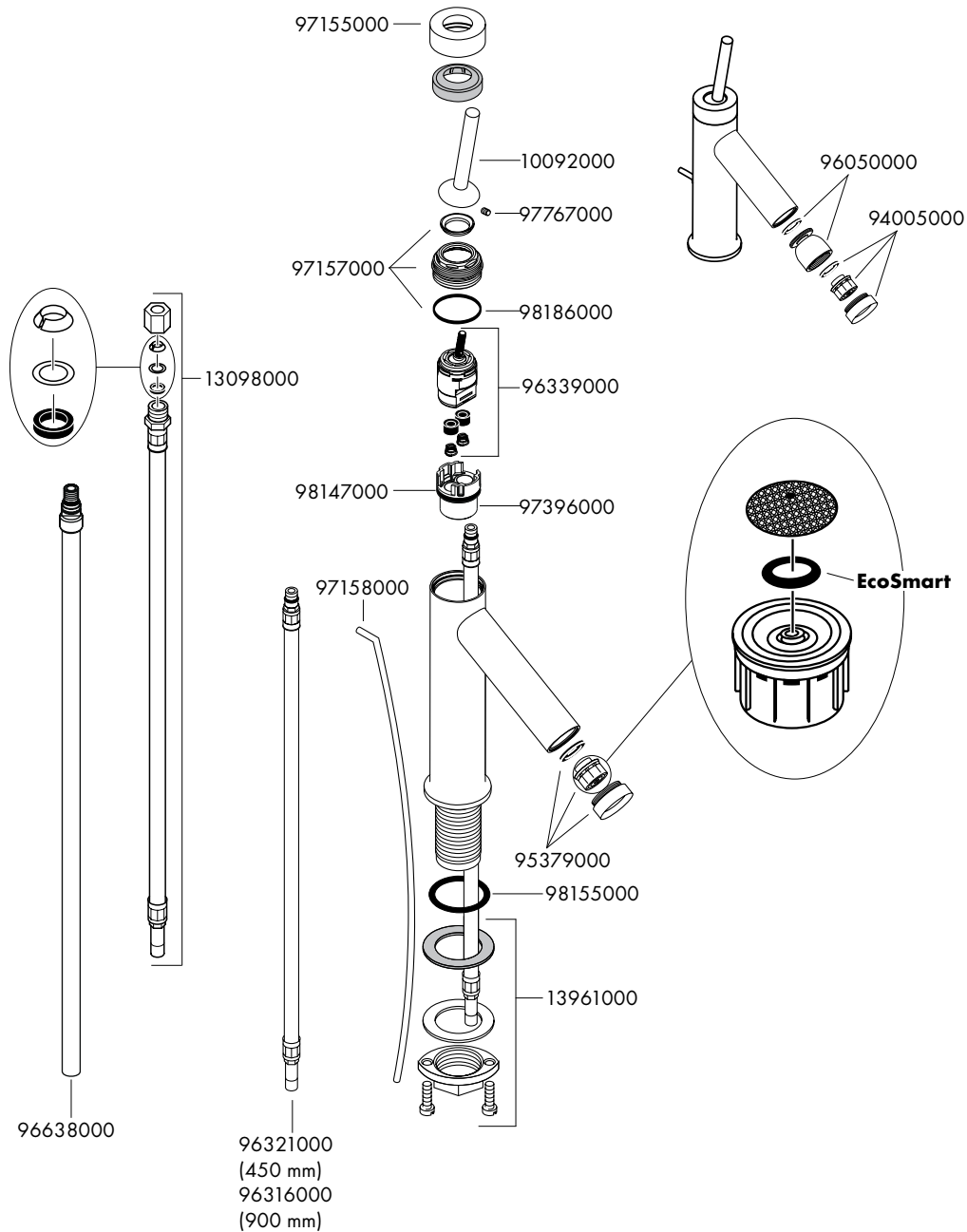

hansgrohe

Hansgrohe - Postfach 1145 · D-77761 Schiltach · Telefon +49 (0) 78 36/51-1282 · Telefax +49 (0) 7836/511440
E-Mail: info@hansgrohe.com · Internet: www.hansgrohe.com

11/2009
9.05025.06