

Hafa® Eden

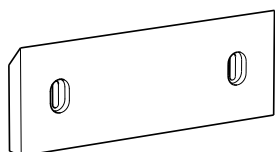

1 x a

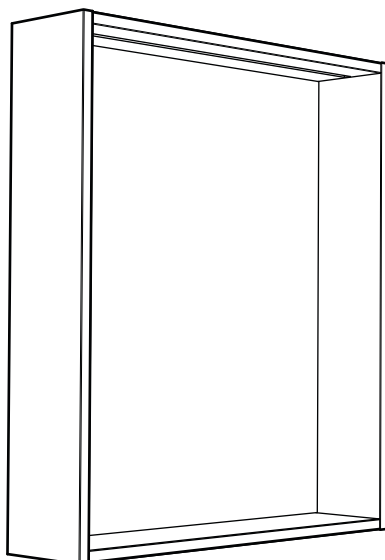

2 x b



1 x c



1 x d

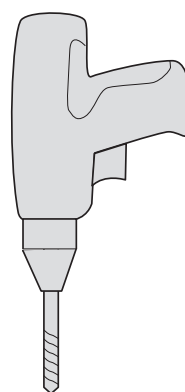

Hafa®

Hafa
Svarvaregatan 5, Box 525
SE-301 80 Halmstad
SWEDEN

Garanti/Warranty.
Service, reservdelar/spare parts
Sweden: Tel: +46 (0)35 15 44 75
Norway: Tel: +47 (0)69 31 02 30
Finland: Puh: +358 (0)9 61500940

www.hafa.se
www.hafa.dk
www.hafabad.no
www.hafa.se
www.hafabathroom.ru
www.hafa.eu

E-mail:
service@hafa.se
service@hafabad.no

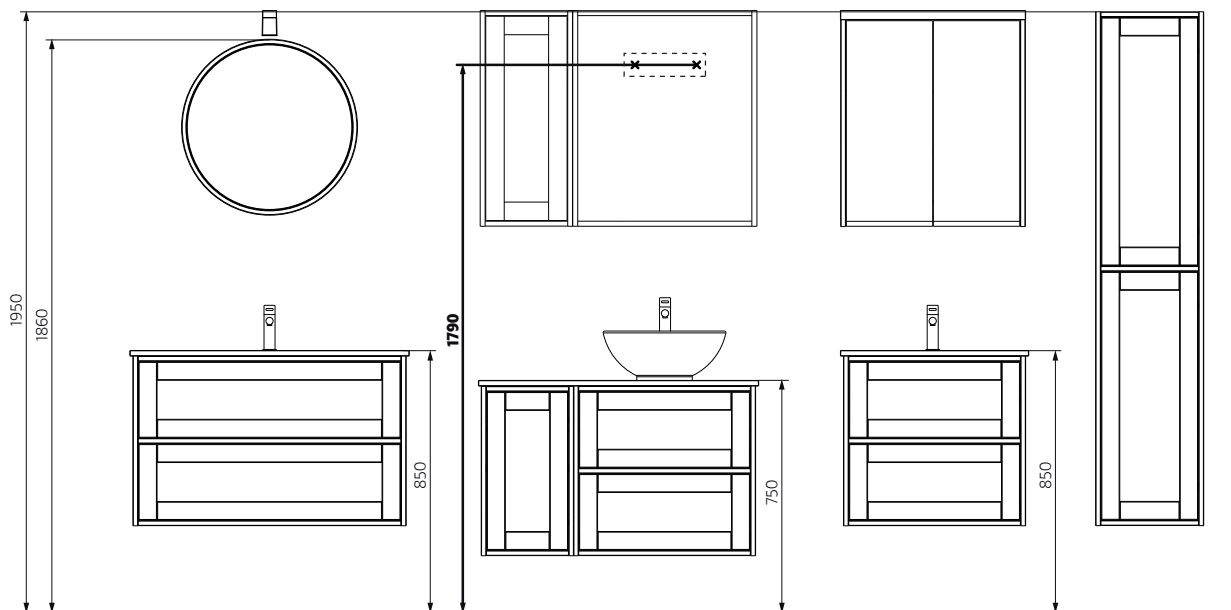

1

230 V

OBS! Endast behörig elektriker
 OBS! Må bare monteres av autorisert elektikker
 OBS! Skal tilsluttes af autoriseret elektriker
 HUOM! Vain asianmukainen sähkömies
 NOTE! Authorized personnel only

**SE**

anslutningstyp: med eller utan skruvar
 antal anslutningar: 2
 märkspänning: 230 V
 anslutningskapacitet: måste passa 2 x 0,75 mm²

DK

Type af klemme: med skrue eller skrueløs
 Antal klemmer: 2
 Mærkespænding: 230 V
 Lederens tværsnitsareal: Skal passe til 2 x 0,75 mm²

NO

type tilkobling: med eller uten skrue
 antall tilkoblingspunkter: 2
 nominell nettspenning: 230 V
 nominell tilkoblingskapasitet: må passe til 2x0,75 mm²

FI

kytkentäliittimen tyyppi: ruuvillinen tai ruuviton
 kytkentäliittimien määrä: 2
 nimellisjännite: 230 V
 tarvittava kytkentäkoko: 2x0,75mm²

GB

type of terminal: screw or screwless
 number of terminals: 2
 rated voltage: 230 V
 rated connecting capacity: must fit for 2x0,75mm²

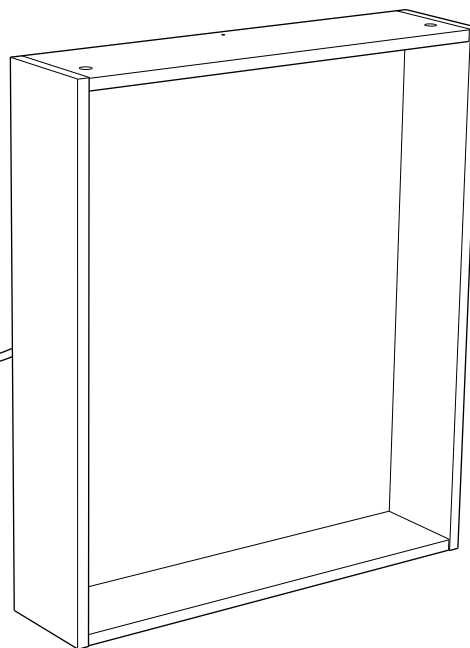

2

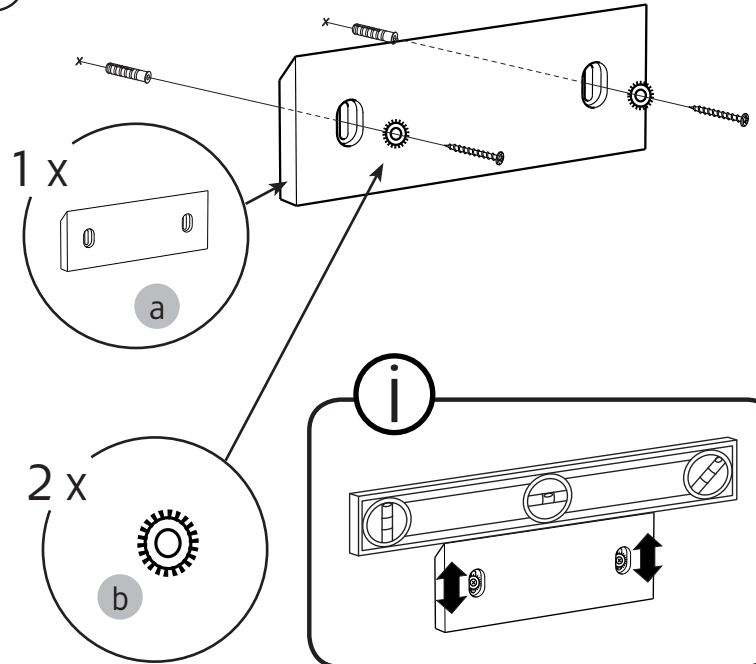
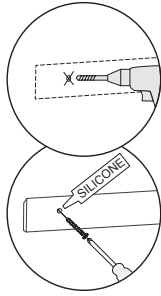
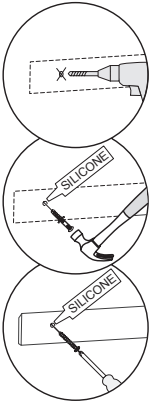
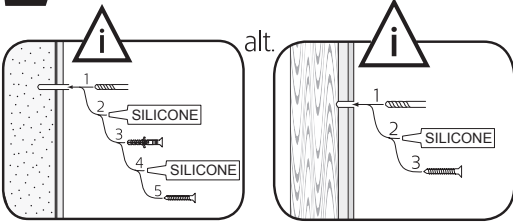

3

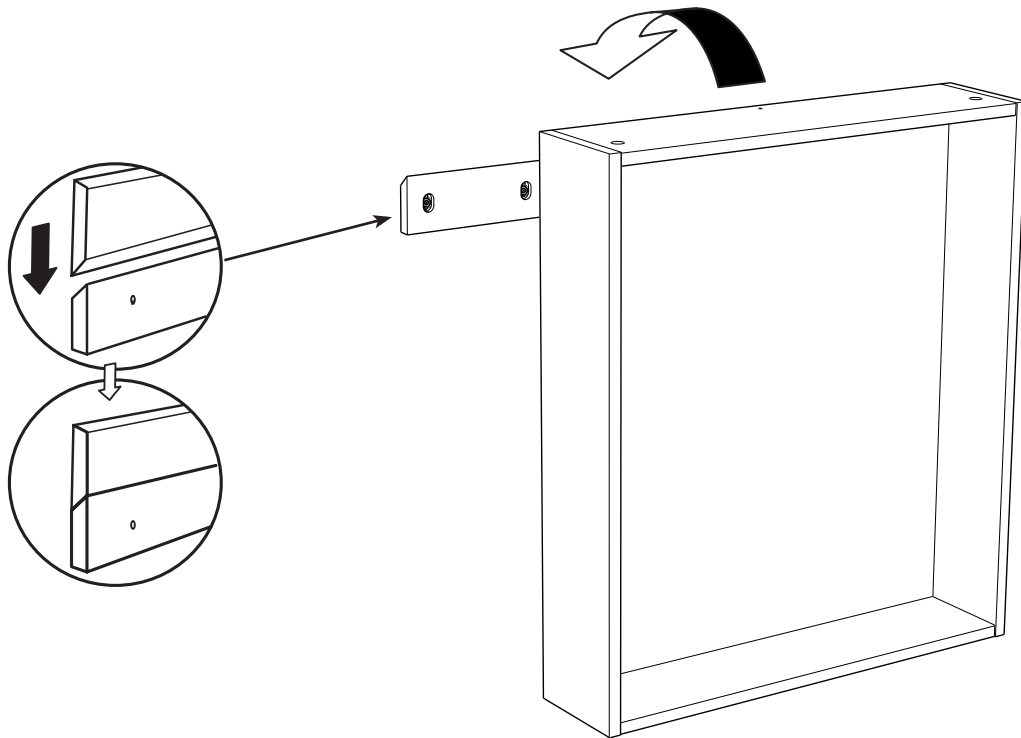

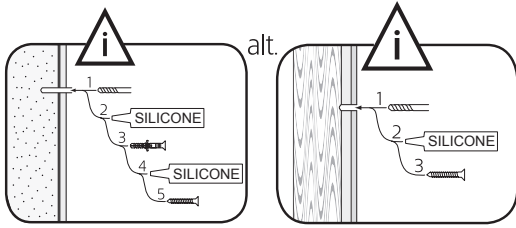

alt.

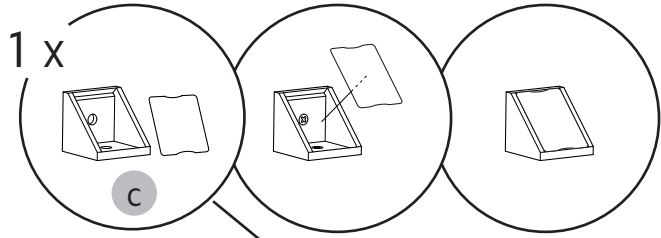

1 x

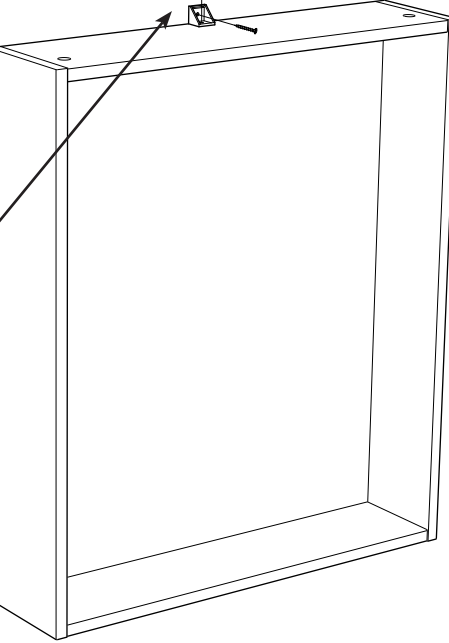

1 x

d

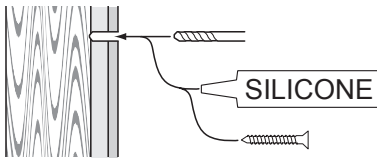
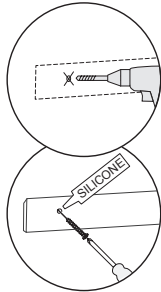
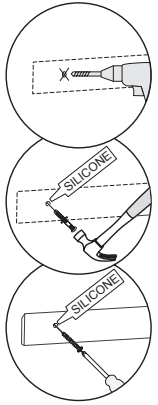

SE

Vid montering på regelvägg på ett avstånd av 1 m från badkar eller dusch måste väggen alltid förstärkas. Alla skruvfästningar skall ske i massiv konstruktion, tex betong, i regler eller särskild konstruktionsdetalj. Skruvfästning får inte göras enbart i golv-, eller väggskiva. Krav på tätning gäller både i våtzon 1 och 2. Material för tätning ska fästa mot underlaget och vara vattenbeständigt, mögelresistent och åldersbeständigt.

alt.

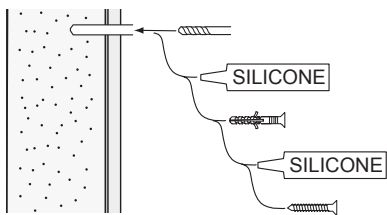

GB

Below are Swedish recommendations:
When installing on a stud wall at a distance of 1 m from a bath or shower, the wall must always be strengthened. All screws must be fixed to solid structures, such as concrete, studs or special structural components. Screws must not be fixed to flooring or wall sheets alone. Requirements for sealing apply in wet zones 1 and 2. Sealing materials must be fixed to the underlying layer and must be waterproof, mould-resistant and age-resistant.



Denna produkt är anpassad till Branschregler Säker Vatteninstallation. Hafa garanterar produktens funktion om branschreglerna och monteringsanvisningarna följs. Ett auktoriserat VVS-företag är garanti för att installationen utförs fackmannamässigt.

Hafa[®]

Hafa
Svarvaregatan 5, Box 525
SE-301 80 Halmstad
SWEDEN

Garanti/Warranty.
Service, reservdelar/spare parts
Sweden: Tel: +46 (0)35 15 44 75
Norway: Tel: +47 (0)69 31 02 30
Finland: Puh: +358 (0)9 61500940

www.hafa.se
www.hafa.dk
www.hafabad.no
www.hafa.se
www.hafabathroom.ru
www.hafa.eu

E-mail:
service@hafa.se
service@hafabad.no